



# BEVERAGE-AIR

3779 Champion Blvd., Winston-Salem, NC 27105  
1-888-845-9800 Fax# 1-336-245-6453  
<http://www.Beverage-Air.com>

(800) 343-6890 [srscooks.com](http://srscooks.com)

THE  
SEATTLE  
RESTAURANT  
S ♦ O ♦ R ♦ E

**CUSTOMER'S CHOICE FOR A HOT KITCHEN**  
**Tested & Certified to Ambient Class of 100°F**

**FOOD PREPARATION  
SERIES PREP TABLES**  
SPE60 ELITE SERIES  
STANDARD TOP

**MODELS:**  
SPE60-08  
SPE60-10  
SPE60-12  
SPE60-16

## 3 Year Parts/Labor Warranty Additional 2 Year Compressor Warranty

### SPE60 ELITE SERIES — STANDARD TOP

All around prep table with enhanced refrigeration system. Improved airflow and less temperature gradient inside the cabinet. Better airflow management and uniform temperature distribution throughout the cabinet. Pans are cooled from the bottom, eliminating the necessity of air blanket. Airflow assures that product in open containers is kept below 41°F and above freezing. This translates into increased product shelf life, higher quality food, better food appearance, fresher product and a reduction of bacteria build-up to combat food-borne illnesses.

### CABINET CONSTRUCTION

Exterior construction includes heavy-duty stainless steel finish on front, sides, top, door(s) and grille. Removable hoods and insulated lid assemblies are made of matching stainless steel. Cabinet back and bottom are constructed of galvanized steel. Interior liner is made of aluminum for superior resistance to corrosion.

Doors are mounted to face of cabinet on cartridge style hinges permitting them to self close under their own weight. Hinges also allow doors to stay open 120° and permit easy door removal for service and cleaning if required. A plug in type vinyl magnetic gasket is attached to each door for positive seal. Door handle is made from extruded aluminum with a black anodized finish. It is contoured to permit easy opening of doors with fingers from both top and bottom of handle.

Cabinet insulation is CFC free foamed-in-place polyurethane of two-inch minimum thickness. Six-inch casters, 2 with brakes, are standard. Legs are available as an option.

Cutting board supplied with cabinet is 10" wide constructed of high-density white polyethylene plastic. It is readily removable for cleaning. Two epoxy-coated steel wire shelves per section are supplied as standard. Pans furnished are 4" deep and made of polycarbonate plastic.

### REFRIGERATION

More robust refrigeration system provides added capacity and efficiency. Systems are designed using CFC free R134a refrigerant. Forced air from evaporator is moved under pans, which are recessed 2" from top of cabinet. Forced air over the condenser is drawn from back and bottom of cabinet. Automatic condensate evaporator is provided to eliminate the need of floor drains.



**SPE60-16**

### ELECTRICAL CONNECTION

Units pre-wired at factory and include 8' long cord and plug





**BEVERAGE-AIR**

**Food Preparation Table — Standard Top**  
**Models: SPE60-08, SPE60-10, SPE60-12, SPE60-16**

MODEL	SPE60-08	SPE60-10	SPE60-12	SPE60-16
<b>EXTERNAL DIMENSIONAL DATA</b>				
Length Overall (inches)	60"	60"	60"	60"
Length Overall (mm)	1524	1524	1524	1524
Depth Overall (inches)	29 1/4"	29 1/4"	29 1/4"	29 1/4"
Depth Overall (mm)	743	743	743	743
Height Overall—(inches)	41 11/16"	41 11/16"	41 11/16"	41 11/16"
Height Overall—(mm)	1059	1059	1059	1059
Number of doors	2	2	2	2
Depth with Door Open 90 °	54"	54"	54"	54"
Clear Door Opening (inches)	22 1/2" x 21 1/2"	22 1/2" x 21 1/2"	22 1/2" x 21 1/2"	22 1/2" x 21 1/2"
<b>INTERNAL DIMENSIONAL DATA</b>				
NET Capacity (cubic ft.)	17.1	17.1	17.1	17.1
NET Capacity (Liters)	484	484	484	484
Internal Length Overall (inches)	56"	56"	56"	56"
Internal Length Overall (mm)	1422	1422	1422	1422
Internal Depth Overall (inches)	19"	19"	19"	19"
Internal Depth Overall (mm)	483	483	483 </td <td>483</td>	483
Internal Height Overall—(inches)	23"	23"	23"	23"
Internal Height Overall—(mm)	584	584	584	584
Number of shelves	4	4	4	4
<b>ELECTRICAL DATA</b>				
Full Load Amperes 115/60/1	9.6	9.6	9.6	9.6
<b>ENERGY CONSUMPTION (KWH)</b>				
	4.4	4.4	4.4	4.4
<b>REFRIGERATION DATA</b>				
Horsepower	1/3	1/3	1/3	1/3
<b>WEIGHT DATA</b>				
Gross Weight (Crated lbs)	357	363	367	383
Gross Weight (Crated kg)	162	165	167	174

**PLAN VIEWS**

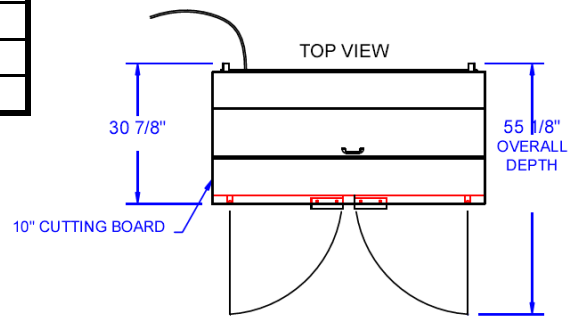
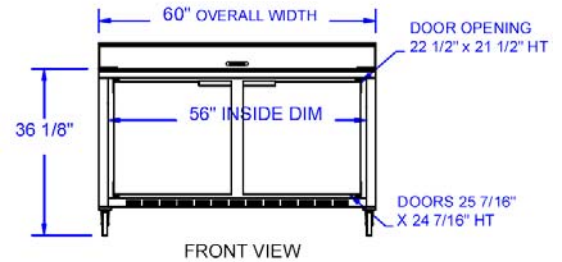
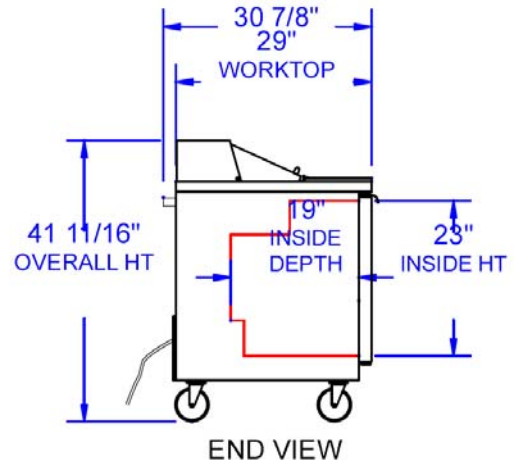

**SPE60-08  
TOP VIEW**

**SPE60-10  
TOP VIEW**

**SPE60-12  
TOP VIEW**

**SPE60-16  
TOP VIEW**

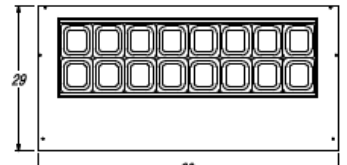
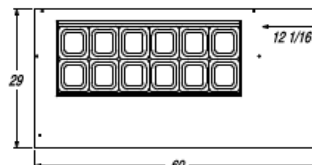
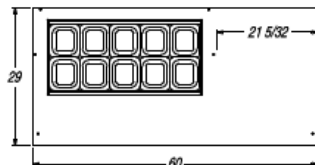
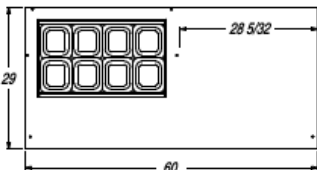

**BEVERAGE-AIR® CORPORATION**

3779 Champion Blvd. • Winston-Salem, NC 27105 USA • (336) 245-6400 • Fax (336) 245-6453 • (888) 845-9800 • www.beverage-air.com

Specifications are subject to change without prior notice. 06/13